



AH1-1

High Dynamic Range Amplifier

Product Features

- 250 – 3000 MHz
- +41 dBm OIP3
- 2.7 dB Noise Figure
- 13.5 dB Gain
- +21 dBm P1dB
- Lead-free/Green/RoHS-compliant SOT-89 Package
- Single +5 V Supply
- MTTF > 100 years

Applications

- Mobile Infrastructure
- CATV / DBS
- W-LAN / ISM
- RFID
- Defense / Homeland Security
- Fixed Wireless

Product Description

The AH1-1 is a high dynamic range amplifier in a low-cost surface-mount package. The combination of low noise figure and high output IP3 at the same bias point makes it ideal for receiver and transmitter applications. The AH1-1 is a specially screened version of the AH1 offering a very narrow gain spread from device to device.

The device combines dependable performance with superb quality to maintain MTTF values exceeding 100 years at mounting temperatures of +85°C. The AH1-1 is available in both the standard SOT-89 package and the environmentally-friendly lead-free/green/RoHS-compliant SOT-89 package.

The broadband amplifier uses a high reliability GaAs MMIC technology and is targeted for applications where high linearity is required. It is well suited for various current and next generation wireless technologies such as GPRS, GSM, CDMA, and W-CDMA. In addition, the AH1-1 will work for other applications within the 250 to 3000 MHz frequency range such as fixed wireless.

Functional Diagram

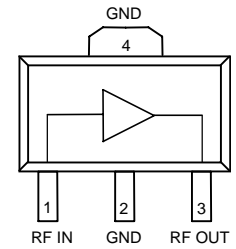

Function	Pin No.
Input	1
Output/Bias	3
Ground	2, 4

Specifications ⁽¹⁾

Parameter	Units	Min	Typ	Max
Operational Bandwidth	MHz	250		3000
Test Frequency	MHz		800	
Gain	dB	12.9	13.3	13.8
Input Return Loss	dB		8	
Output Return Loss	dB		15	
Output P1dB	dBm		+21	
Output IP3 ⁽²⁾	dBm	+37	+41	
Noise Figure ⁽³⁾	dB		2.7	
Operating Current Range	mA	120	150	180
Supply Voltage	V		5	

1. Test conditions unless otherwise noted: T = 25° C, 50 Ω system.
 2. 3OIP measured with two tones at an output power of +5 dBm/tone separated by 10 MHz. The suppression on the largest IM3 product is used to calculate the 3OIP using a 2:1 rule.
 3. Noise figure can be optimized by matching the input for optimal return loss.

Typical Performance ⁽⁴⁾

Parameter	Units	Typical		
Frequency	MHz	900	1900	2140
S21	dB	14.2	12.2	12.0
S11	dB	-21	-14	-21
S22	dB	-14	-13	-11
Output P1dB	dBm	+21.7	+22	+22
Output IP3 ⁽²⁾	dBm	+42	+41	+40
IS-95 Channel Power ⁽⁵⁾	dB	+15.5	+16.5	
Noise Figure	dB	2.2	2.9	2.9
Supply Voltage	V		5	
Device Current	mA		150	

4. Parameters reflect performance in an AH1-PCB application circuit, as shown on page 3.
 5. Measured with -45 dBc ACPR, IS-95 9 channels fwd.

Absolute Maximum Rating

Parameter	Rating
Operating Case Temperature	-40 to +85 °C
Storage Temperature	-55 to +150 °C
Supply Voltage	+6 V
RF Input Power (continuous)	+10 dBm
Junction Temperature	+220 °C

Operation of this device above any of these parameters may cause permanent damage.

Ordering Information

Part No.	Description
AH1-1	High Dynamic Range Amplifier (leaded SOT-89 Pkg)
AH1-1G	High Dynamic Range Amplifier (lead-free/green/RoHS-compliant SOT-89 Pkg)
AH1-PCB	0.8 – 2.5 GHz Fully Assembled Application Circuit

Specifications and information are subject to change without notice.



Typical Device Data

S-Parameters ($V_{DS} = +5\text{ V}$, $I_{DS} = 150\text{ mA}$, $T = 25^\circ\text{C}$, unmatched device in a 50 ohm system)

Input return loss can be improved with the appropriate input matching network shown later in this datasheet.

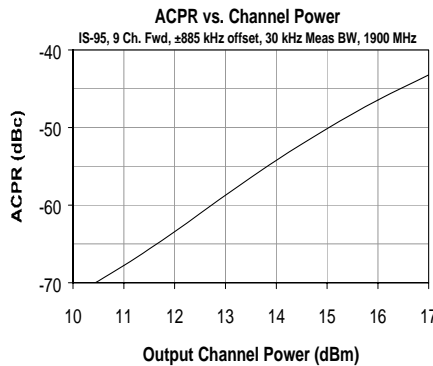
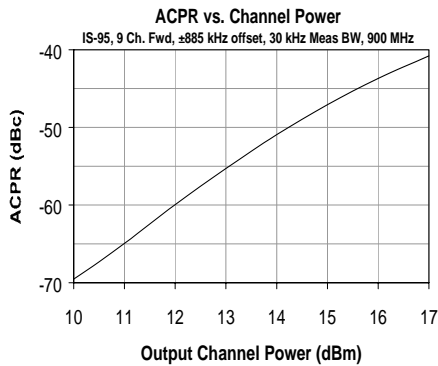
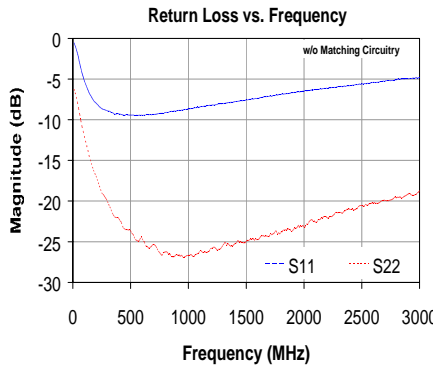
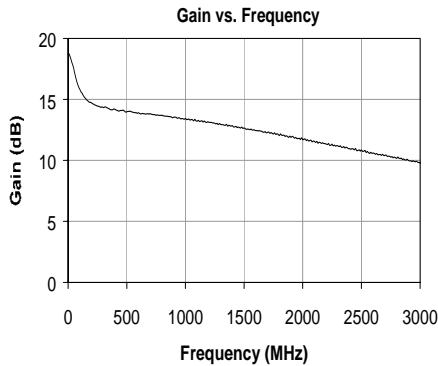
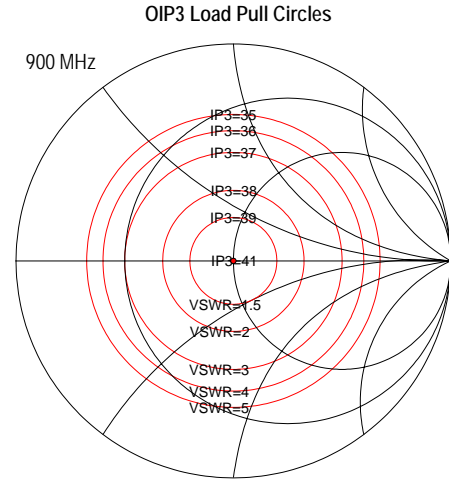
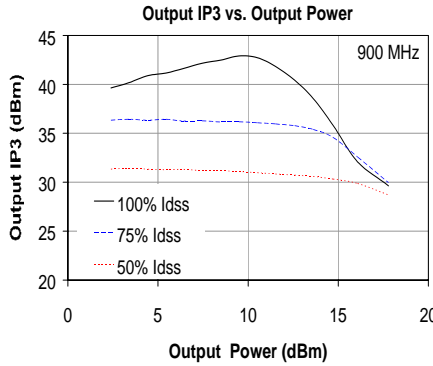
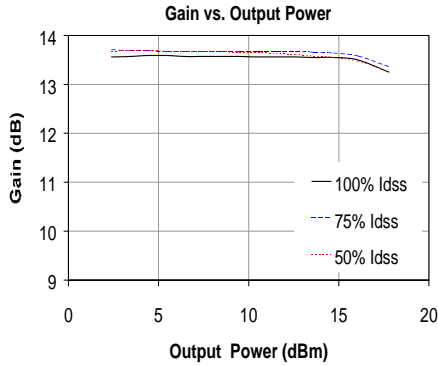

S-Parameters ($V_D = +5\text{ V}$, $I_D = 150\text{ mA}$, $T = 25^\circ\text{C}$, calibrated to device leads)

Freq (MHz)	S11 (dB)	S11 (ang)	S21 (dB)	S21 (ang)	S12 (dB)	S12 (ang)	S22 (dB)	S22 (ang)
50	-2.24	-0.36	17.17	164.69	-23.16	50.85	-5.86	-33.21
250	-4.76	-0.36	15.74	161.34	-20.54	31.24	-8.86	-47.02
500	-7.30	-0.30	14.67	160.30	-19.45	14.79	-13.03	-52.43
750	-8.66	-0.30	14.11	154.63	-19.15	3.75	-16.72	-49.89
1000	-8.70	-0.34	13.83	146.75	-19.05	-1.71	-18.22	-48.40
1250	-8.32	-0.38	13.62	138.48	-18.99	-5.88	-19.16	-52.48
1500	-7.78	-0.41	13.36	129.80	-18.99	-9.79	-20.14	-59.84
1750	-7.32	-0.41	13.03	121.57	-18.96	-12.84	-20.93	-68.57
2000	-6.82	-0.40	12.80	113.51	-18.87	-16.17	-21.11	-76.23
2250	-6.46	-0.37	12.52	104.74	-18.89	-19.71	-21.15	-83.31
2500	-6.24	-0.32	12.14	96.55	-18.93	-23.30	-21.55	-90.61
2750	-5.74	-0.26	11.81	88.90	-18.93	-26.26	-22.52	-94.38
3000	-5.25	-0.19	11.45	81.33	-18.92	-29.49	-24.14	-104.23



AH1-1

High Dynamic Range Amplifier

The Communications Edge™

Product Information

Application Circuit: 800 – 2500 MHz (AH1-PCB)

Typical RF Performance at 25°C

Frequency	Units	900	1900	2140
S21 – Gain	dB	14.2	12.2	12.0
S11 – Input R.L.	dB	-21	-14	-21
S22 – Output R.L.	dB	-14	-13	-11
Output P1dB	dB	+21.7	+22	+22
Output IP3 (+5 dBm / tone, 10 MHz spacing)	dB	+42	+41	+40
IS-95 Channel Power (@-45 dBc ACPR, 9 channels fwd)	dB	+15.5	+16.5	
Noise Figure	dB	2.2	2.9	2.9
Device Bias		+5V @ 150mA		

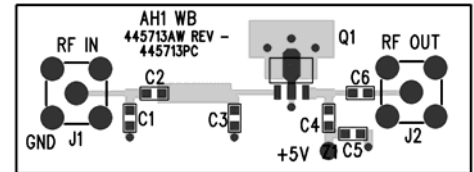
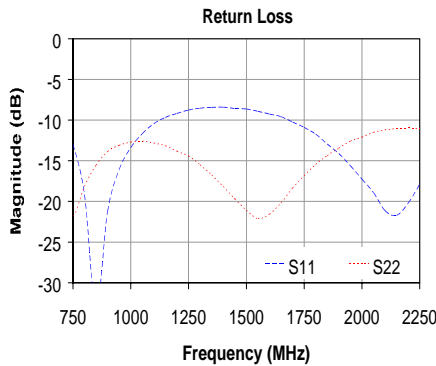
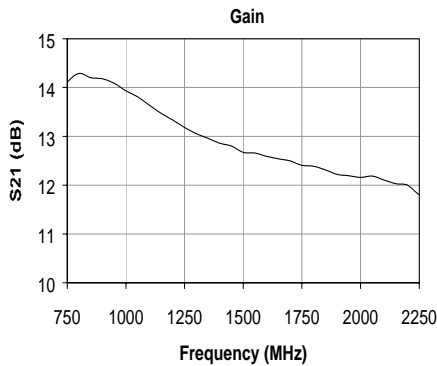
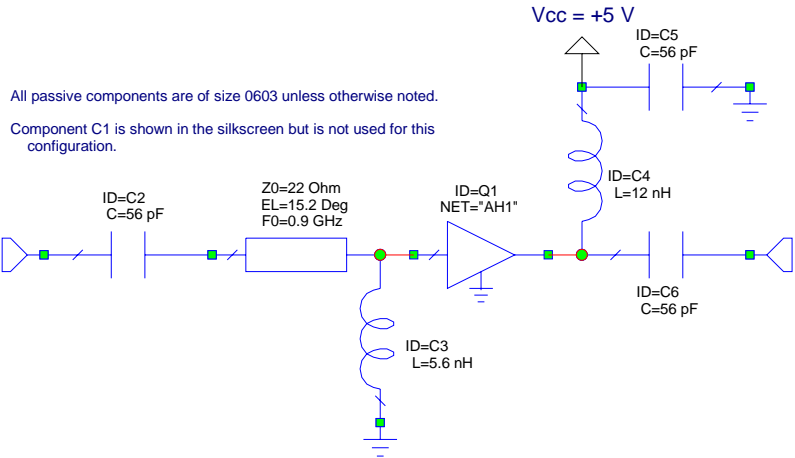

Circuit Board Material: .062" total thickness with a .014" FR-4 top RF layer, 4 layers (other layers added for rigidity), 1 oz copper, 50Ω Microstrip line details: width = .025".



AH1-1

High Dynamic Range Amplifier

The Communications Edge™

Product Information

AH1-1G (Green / Lead-free SOT-89 Package) Mechanical Information

This package is lead-free/Green/RoHS-compliant. It is compatible with both lead-free (maximum 260°C reflow temperature) and leaded (maximum 245°C reflow temperature) soldering processes. The plating material on the leads is NiPdAu.

Outline Drawing

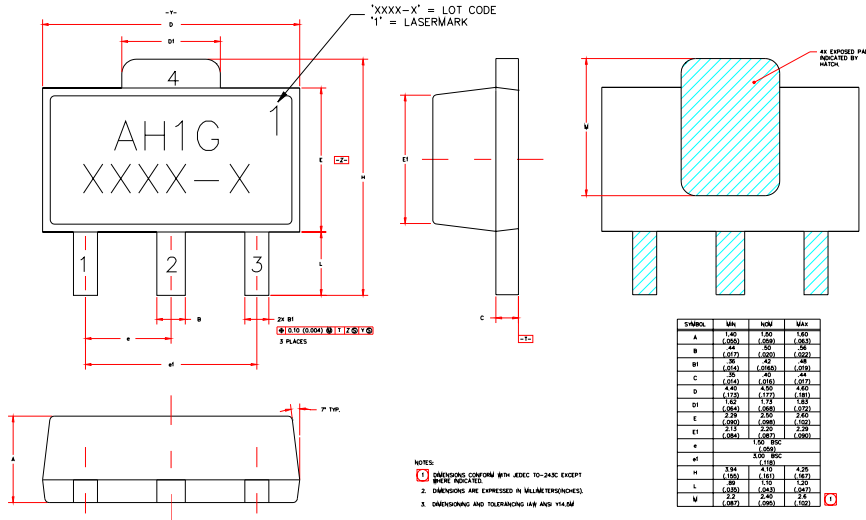

Product Marking

The AH1-1G will be marked with an "AH1G" designator. An alphanumeric lot code ("XXXX-X") is also marked below the part designator on the top surface of the package. A "1" will be lasermarked in the upper right-hand corner.

Tape and reel specifications for this part are located on the website in the "Application Notes" section.

MSL / ESD Rating



Caution! ESD sensitive device.

ESD Rating: Class 1B
 Value: Passes $\geq 500V$ to $<1000V$
 Test: Human Body Model (HBM)
 Standard: JEDEC Standard JESD22-A114

ESD Rating: Class IV
 Value: Passes $\geq 1000V$ to $<2000V$
 Test: Charged Device Model (CDM)
 Standard: JEDEC Standard JESD22-C101

MSL Rating: Level 3 at $+260^\circ C$ convection reflow
 Standard: JEDEC Standard J-STD-020

Land Pattern

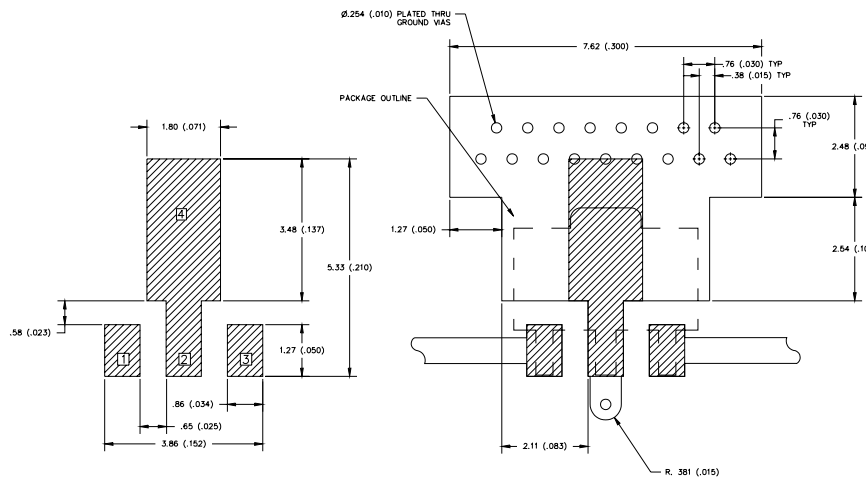

Thermal Specifications

Parameter	Rating
Operating Case Temperature	-40 to +85°C
Thermal Resistance, Rth ⁽¹⁾	59° C / W
Junction Temperature, Tj _c ⁽²⁾	129° C

- The thermal resistance is referenced from the hottest part of the junction to the ground tab (pin 4).
- This corresponds to the typical biasing condition of +5V, 150 mA at an 85°C case temperature. A minimum MTTF of 1 million hours is achieved for junction temperatures below 160 °C.

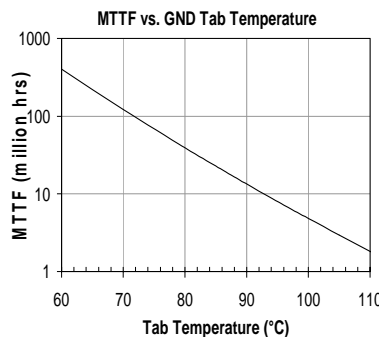

Mounting Config. Notes

- Ground / thermal vias are critical for the proper performance of this device. Vias should use a .35mm (#80 / .0135") diameter drill and have a final plated thru diameter of .25mm (.010").
- Add as much copper as possible to inner and outer layers near the part to ensure optimal thermal performance.
- Mounting screws can be added near the part to fasten the board to a heatsink. Ensure that the ground / thermal via region contacts the heatsink.
- Do not put solder mask on the backside of the PC board in the region where the board contacts the heatsink.
- RF trace width depends upon the PC board material and construction.
- Use 1 oz. Copper minimum.
- All dimensions are in millimeters (inches). Angles are in degrees.

Specifications and information are subject to change without notice.